

Model numbers of panel base tables

G	01H	N
Panel base tables	Model	Type

N=Normal tables
J=Righthand tables
B=Lefthand tables

Model nr. for extension tables (for panel base tables)

G	60F	J
Panel base tables	Model	Type

J=Righthand extension
B=Lefthand extension

Model numbers of "C" base tables

CH	111	N
"C" base tables	Model	Type

N=Normal tables
J=Righthand tables
B=Lefthand tables

Model numbers of "4" legged tables

CL	A	111	N
"4" leg tables	Top thick.	Model	Type

A:19mm thick table top
B:25mm thick table top
N=Normal tables
J=Righthand tables
B=Lefthand tables

Model number for extension tables ("C", and "4" base tables)

C	AS35	J
	Model	Type

J=Righthand extension
B=Lefthand extension

Options

l	x	y	z	f	k
Base type	Top panel surface	Front panel surface	Base panel surface	Metal surface	Cable cover

N=Normal base
J=Recessed base on the right side
B=Recessed base on the left side
(Extra charge for base relief)

42=Silber
1F=Black
2E=Hazel decor
LG=Light grey
1P=Grey-white
KV=Beech decor
1J=Maple decor
1N=Walnut decor
KS=Cherry decor
1D=Apple decor

23=Platina metal
10=Black
21=Anthracite metal
46=Pure white
K=Cable cover on both sides
E=one cable cover in the middle
(Extra charge for cable covers)

Options

x	f
Top panel surface	Metal surface

42=Silber
1F=Black
2E=Hazel decor
LG=Light grey
1P=Grey-white
KV=Beech decor
1J=Maple decor
1N=Walnut decor
KS=Cherry decor
1D=Apple decor

23=Platina metal
10=Black
21=Anthracite metal
46=Pure white

Options

x	f	l	y	k
Top panel colours	Metal frame	Base inlay surface	Front panel surface	Cable cover

42=Silber
1F=Black
2E=Hazel decor
LG=Light grey
1P=Grey-white
KV=Beech decor
1J=Maple decor
1N=Walnut decor
KS=Cherry decor
1D=Apple decor

23=Platina metal
10=Black
21=Anthracite metal
46=Pure white
----=No Base inlay
23=Platina metal
10=Black
21=Anthracite metal
46=Pure white
(Extra price)

----=No front panel
42=Silber
1F=Black
2E=Hazel decor
LG=Light grey
1P=Grey-white
KV=Beech decor
1J=Maple decor
1N=Walnut decor
KS=Cherry decor
1D=Apple decor
(Extra price)

J=Cable cover on the right
B=Cable cover on the left
K=Cable cover on both sides
(Extra charge for cable covers)

Options

x	f	k
Top panel surface	Metal frame	Cable cover

42=Silber
1F=Black
2E=Hazel decor
LG=Light grey
1P=Grey-white
KV=Beech decor
1J=Maple decor
1N=Walnut decor
KS=Cherry decor
1D=Apple decor

23=Platina metal
10=Black
21=Anthracite metal
46=Pure white
J=Cable cover on the right
B=Cable cover on the left
K=Cable cover on both sides
(Extra charge for cable covers)

Options

x	f
Top panel surface	Metal surface

42=Silber
1F=Black
2E=Hazel decor
LG=Light grey
1P=Grey-white
KV=Beech decor
1J=Maple decor
1N=Walnut decor
KS=Cherry decor
1D=Apple decor



23=Platina metal
10=Black
21=Anthracite metal
46=Pure white

Options



l	x	y	z	f	k
Base type	Top panel surface	Front panel surface	Panel base surface	Metal surface	Cable cover
N=Normal base J=Recessed base on the right side B=Recessed base on the left side (Extra charge for recessed base)	42=Silber 1F=Black 2E=Hazel decor LG=Light grey 1P=Grey-white	KV=Beech decor 1J=Maple decor 1N=Walnut decor KS=Cherry decor 1D=Apple decor		23=Platina metal 10=Black 21=Anthracite metal 46=Pure white	J=Cable cover on the right B=Cable cover on the left K=Cable cover on both sides (Extra charge for cable covers)

Tables are always squared, straight edged and contain cable ducts. Relieved bases always contain cable outlet holes. Tables are delivered unassembled.

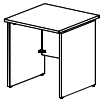
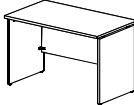
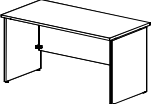
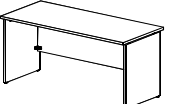
70 cm deep tables with 25 mm squared, straight edge laminated table tops

Basic design			Extra designs		
normal base no cable cover			Recessed base on the right (J) or left (B) side	One cable cover on the right (J) or on the left (B)	Two cable covers both sides
Height: 75 cm	Sizes (cm)				
	length	depth			
	70	70	G11HN		
	120	70	G12HN		
	140	70	G13HN		
	160	70	G14HN		

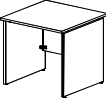
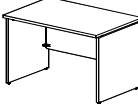
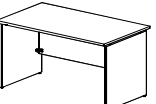
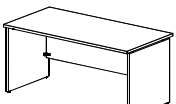
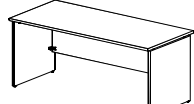
80 cm deep tables with 25 mm squared, straight edge laminated table tops





	80	80	G01HN		
	120	80	G02HN		
	140	80	G03HN		
	160	80	G04HN		
	180	80	G05HN		
	200	80	G36HN		

Options

l	x	y	z	f	k
Base design	Table top surface	Front surface	Base surface	Metal surface	Cable cover
N=Normal base J=Recessed base on the right side B=Recessed base on the left side (Extra charge for recessed base)	42=Silber 1F=Black 2E=Hazel decor LG=Light grey 1P=Grey-white	KV=Beech decor 1J=Maple decor 1N=Walnut decor KS=Cherry decor 1D=Apple decor		23=Platina metal 10=Black 21=Anthracite metal 46=Pure white	J=Cable cover on the right B=Cable cover on the left K=Cable cover on both sides (Extra charge for cable covers)

Tables are always squared, straight edged and contain cable ducts. Relieved bases always contain cable outlet holes. Tables are delivered unassembled.

Freeform tables with 25 mm squared, straight edge laminated table tops

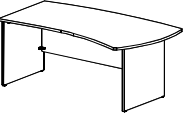
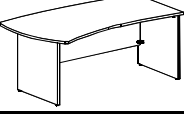
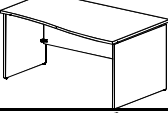
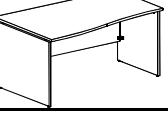
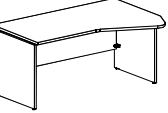
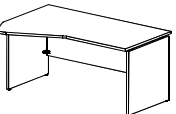
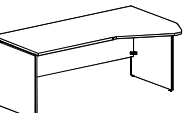
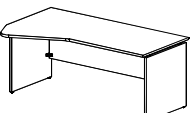
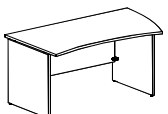
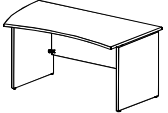
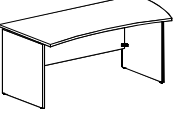
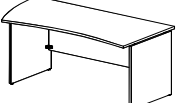

Basic design			Extra designs			
normal base no cable cover			Recessed base on the right (J) or left (B) side	One cable cover on the right (J) or on the left (B)	2 cable covers both sides	
Height: 75 cm	Sizes (cm)					
	length	depth				
	180	102,5	G19HJ	recessed base available on the left side only		
	righthanded connecting edge 80 cm					
	180	102,5	G19HB	recessed base available on the right side only		
	lefthanded connecting edge 80 cm					
	160	100/80	G20HJ	recessed base available on the left side only		
	righthanded connecting edge 80 cm					
	160	100/80	G20HB	recessed base available on the right side only		
	lefthanded connecting edge 80 cm					
	160	108	G35HJ	recessed base available on the left side only		
	righthanded connecting edge 80 cm					
	160	108	G35HB	recessed base available on the right side only		
	lefthanded connecting edge 80 cm					
	180	108	G36HJ	recessed base available on the left side only		
	righthanded connecting edge 80 cm					
	180	108	G36HB	recessed base available on the right side only		
	lefthanded kapcsolódó él 80 cm					
	160	90	G37HJ	recessed base available on the left side only		
	righthanded					
	160	90	G37HB	recessed base available on the right side only		
	lefthanded					
	180	90	G38HJ	recessed base available on the left side only		
	righthanded					
	180	90	G38HB	recessed base available on the right side only		
	lefthanded					

Options

l	x	y	z	f	k
Base design	Table top surface	Front surface	Base surface	Metal surface	Cable cover
N=Normal base J=Recessed base on the right side B=Recessed base on the left side (Extra charge for recessed base)	42=Silber 1F=Black 2E=Hazel decor LG=Light grey 1P=Grey-white	KV=Beech decor 1J=Maple decor 1N=Walnut decor KS=Cherry decor 1D=Apple decor		23=Platina metal 10=Black 21=Anthracite metal 46=Pure white	J=Cable cover on the right B=Cable cover on the left K=Cable cover on both sides (Extra charge for cable covers)

Tables are always squared, straight edged and contain cable ducts. Relieved bases always contain cable outlet holes. Tables are delivered unassembled.

Tables with 25 mm straight edge laminated table tops that may be connected to 60 cm deep extension tables

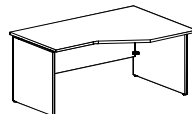
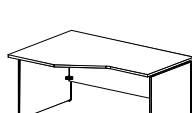
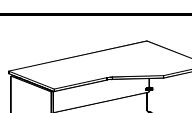
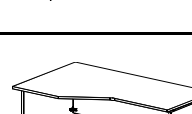
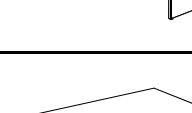
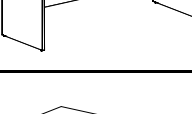
Basic design			Extra designs		
normal bases no cable covers			Recessed base on the right (J) or left (B) side	One cable cover on the right (J) or on the left (B)	2 cable covers both sides
Height: 75 cm	Sizes (cm) length depth				
	160 110/80	G39HJ	recessed base available on the left side only		
	160 110/80	G39HB	recessed base available on the right side only		
	180 110/80	G40HJ	recessed base available on the left side only		
	180 110/80	G40HB	recessed base available on the right side only		
	200 110/80	G41HJ	recessed base available on the left side only		
	200 110/80	G41HB	recessed base available on the right side only		

60 cm deep extension tables with 25 mm squared, straight edge laminated table tops

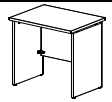
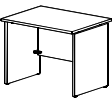
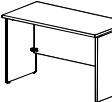

	80 60	G30HN			
	90 60	G32HN			
	120 60	G31HN			

Options



l	x	y	z	f	k
Base design	Table top surface	Front surface	Base surface	Metal surface	Cable cover
N=Normal base J=Recessed base on the right side B=Recessed base on the left side (Extra charge for recessed base)	42=Silber 1F=Black 2E=Hazel decor LG=Light grey 1P=Grey-white	KV=Beech decor 1J=Maple decor 1N=Walnut decor KS=Cherry decor 1D=Apple decor		23=Platina metal 10=Black 21=Anthracite metal 46=Pure white	J=Cable cover on the right B=Cable cover on the left K=Cable cover on both sides H=three cable covers E=one cable cover in the middle (Extra charge for cable covers)

Tables are always squared, straight edged and contain cable ducts. Relieved bases always contain cable outlet holes. Tables are delivered unassembled.

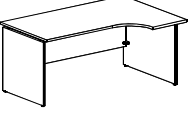
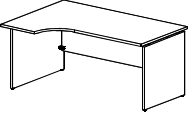
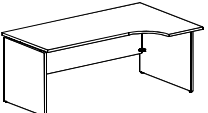
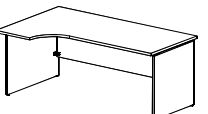
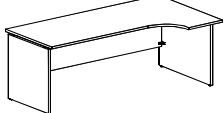
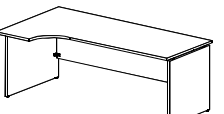
Tables with 25 mm straight edge laminated table tops connecting to side cabinets

Basic design			Extra designs		
normal base no cable cover			Recessed base on the right (J) or left (B) side	One cable cover on the right (J) or on the left (B)	2 cable covers both sides
Height: 75 cm	Sizes (cm)				
	length	depth	G42HJ	recessed base available on the left side only	
80 44 righthanded connecting edge 80/44 cm	160	110/80			
	length	depth	G42HB	recessed base available on the right side only	
80 44 lefthanded connecting edge 80/44 cm	160	110/80			
	length	depth	G43HJ	recessed base available on the left side only	
80 44 righthanded connecting edge 80/44 cm	180	110/80			
	length	depth	G43HB	recessed base available on the right side only	
80 44 lefthanded connecting edge 80/44 cm	180	110/80			
	length	depth	G44HJ	recessed base available on the left side only	
80 44 righthanded connecting edge 80/44 cm	200	110/80			
	length	depth	G44HB	recessed base available on the right side only	
80 44 lefthanded connecting edge 80/44 cm	200	110/80			

120° tables with 25 mm straight edge laminated table tops

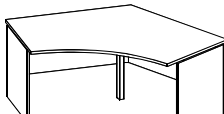

Basic design			Extra designs		
normal bases no cable covers			Recessed base on the right (J), or left (B) side	One cable cover on the right (J), on the left (B), or in the middle (E)	3 cable covers on both sides and in the middle
Height: 75 cm	Sizes (cm)				
	length	depth	G26HJ		
208	129,0				

Options

l	x	y	z	f	k
Base design	Table top surface	Front surface	Base surface	Metal surface	Cable cover
N=Normal base J=Recessed base on the right side B=Recessed base on the left side (Extra charge for recessed base)	42=Silber 1F=Black 2E=Hazel decor LG=Light grey 1P=Grey-white	KV=Beech decor 1J=Maple decor 1N=Walnut decor KS=Cherry decor 1D=Apple decor		23=Platina metal 10=Black 21=Anthracite metal 46=Pure white	J=Cable cover on the right B=Cable cover on the left K=Cable cover on both sides H=three cable covers E=one cable cover in the middle (Extra charge for cable covers)

Tables are always squared, straight edged and contain cable ducts. Relieved bases always contain cable outlet holes. Tables are delivered unassembled.

Tables with 25 mm straight edge laminated table tops that may be connected to 60 cm deep extension tables

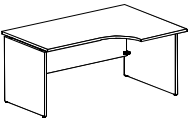
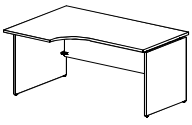
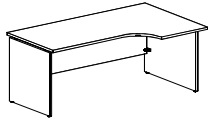
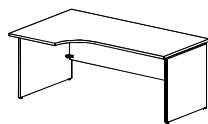
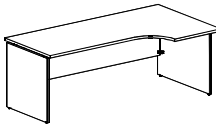
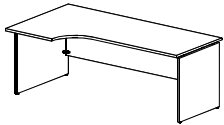
Basic design			Extra designs		
normal base no cable cover			Recessed base on the right (J) or left (B) side	One cable cover on the right (J) or on the left (B)	2 cable covers both sides
Height: 75 cm	Sizes (cm)				
	length	depth			
	160	110/80	G45HJ	recessed base available on the left side only	
80 60 righthanded connecting edge 80/60 cm					
	160	110/80	G45HB	recessed base available on the right side only	
80 60 lefthanded connecting edge 80/60 cm					
	180	110/80	G46HJ	recessed base available on the left side only	
80 60 righthanded connecting edge 80/60 cm					
	180	110/80	G46HB	recessed base available on the right side only	
80 60 lefthanded connecting edge 80/60 cm					
	200	110/80	G47HJ	recessed base available on the left side only	
80 60 righthanded connecting edge 80/60 cm					
	200	110/80	G47HB	recessed base available on the right side only	
80 60 lefthanded connecting edge 80/60 cm					

Undertable pullout keyboard shelves for panel base tables

w:55,4cm
d:35,5cm
h:6-10,7cm
FSF436x
Shelf made of laminated chipboard, clearance adjustable 31-78 mm, with ball guide. Fits all table depths and legths.

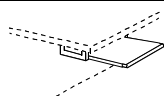

w:75,4cm
d:35,5cm
h:6-10,7cm
FSF437x
Shelf made of laminated chipboard, clearance adjustable 31-78 mm, with ball guide and increased width (for mousepad). Does not fit 70 cm and 80 cm wide tables.

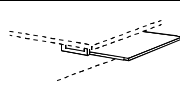

Undertable pullout keyboard tray for panel base tables

w:66cm
d:33cm
h:6cm
FSF43510
Black coloured plastic. Does not fit 70 cm and 80 cm wide tables.

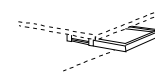

Options

x			f		
Table top surface			Metal surface		
42=Silber	1P=Grey-white	KS=Cherry decor	23=Platina metal	Tables are delivered unassembled. Tubular legs are 6 cm in diameter.	
1F=Black	KV=Beech decor	1D=Apple decor	10=Black		
2E=Hazel decor	1J=Maple decor		21=Anthracite metal		
LG=Light grey	1N=Walnut decor		46=Pure white		

Corner table tops for panel base tables with connectors and cable ducts

length	depth	height		Price	length	depth	height		Price
70	70	90°		G64FH	80	80	90°		G51FH
70	70	90°		G66HN	80	80	90°		G53HN
70	70	75		G67HN	80	80	75		G54HN



Extension tables for panel base tables, with connectors

140	70	75		G69HN	160	80	75		G55HN
120	60	75		G61HJ	80	40	75		G56HN
70	35	75		G68HJ	60	30	75		G75HN
105	105	75		G73HJ G73HB	120	120	75		G60HJ G60HB
140	140	75		G72HJ G72HB	160	160	75		G59HJ G59HB
119,5	70	75		G70HJ G70HB	137	80	75		G57HJ G57HB



Options

x		f	l	y		k
Table top surface		Metal frame	Base inlay surface	Front panel surface		Cable cover
42=Silber 1F=Black 2E=Hazel decor LG=Light grey 1P=Grey-white	KV=Beech decor 1J=Maple decor 1N=Walnut decor KS=Cherry decor 1D=Apple decor	23=Platina metal 10=Black 21=Anthracite metal 46=Pure white	----=No Base inlay 23=Platina metal 10=Black 21=Anthracite metal 46=Pure white (Extra charge for base inlay)	----=No front panel 42=Silber 1F=Black 2E=Hazel decor LG=Light grey 1P=Grey-white (Extra charge for front panel)	KV=Beech decor 1J=Maple decor 1N=Walnut decor KS=Cherry decor 1D=Apple decor	J=Cable cover on the right B=Cable cover on the left K=Cable cover on both sides (Extra charge for cable covers)

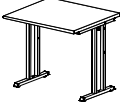
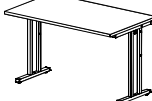
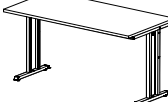
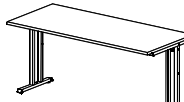
70 cm deep tables with 25 mm squared, straight edge laminated table tops

Basic design			Extra designs			
without base inlay front panel or cable cover			set of two base inlays For C-shaped bases	Laminated front panel	One cable cover on the right (J) or on the left (B)	Two cable covers both sides
Height: 75 cm	Sizes (cm)					
	length	depth				
	80	70	CH121N			
	120	70	CH122N			
	140	70	CH123N			
	160	70	CH124N			

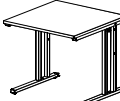
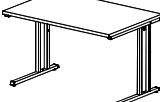
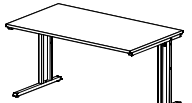
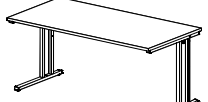
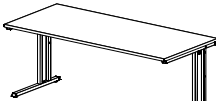





80 cm deep tables with 25 mm squared, straight edge laminated table tops

	80	80	CH113N		
	120	80	CH112N		
	140	80	CH114N		
	160	80	CH111N		
	180	80	CH110N		
	200	80	CH109N		

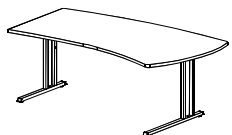
Options

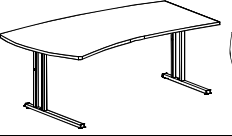
x		f	l	y		k
Table top surface		Metal frame surface	Base inlay surface	Front panel surface		Cable cover
42=Silber 1F=Black 2E=Hazel decor LG=Light grey 1P=Grey-white	KV=Beech decor 1J=Maple decor 1N=Walnut decor KS=Cherry decor 1D=Apple decor	23=Platina metal 10=Black 21=Anthracite metal 46=Pure white	----=No Base inlay 23=Platina metal 10=Black 21=Anthracite metal 46=Pure white (Extra charge for base inlay)	----=No front panel 42=Silber 1F=Black 2E=Hazel decor LG=Light grey 1P=Grey-white (Extra charge for front panel)	KV=Beech decor 1J=Maple decor 1N=Walnut decor KS=Cherry decor 1D=Apple decor	J=Cable cover on the right B=Cable cover on the left K=Cable cover on both sides (Extra charge for cable covers)

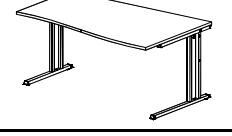
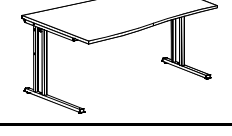
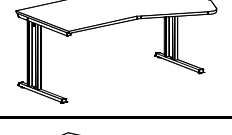
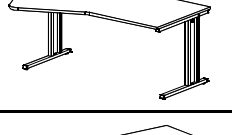
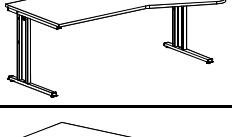
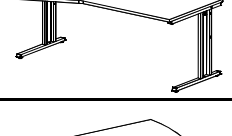
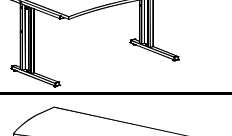
Freeform tables with 25 mm straight edge laminated table tops

Basic design without base inlay, front panel or cable cover			Extra designs			
Height: 75 cm	Sizes (cm)		set of two base inlays For C-shaped bases	Laminated front panel	One cable cover on the right (J) or on the left (B)	2 table covers both sides
	length	depth				
	80	180 102,5				
		righthanded connecting edge 80 cm				
	80	180 102,5				
		table base:160cm lefthanded connecting edge 80 cm				
	80	160 100/80				
		righthanded connecting edge 80 cm				
	80	160 100/80				
		lefthanded connecting edge 80 cm				
	80	160 108/80				
		righthanded connecting edge 80 cm				
	80	160 108/80				
		lefthanded connecting edge 80 cm				
	80	180 108/80				
		righthanded connecting edge 80 cm				
	80	180 108/80				
		lefthanded connecting edge 80 cm				
	90	160 90/90				
		table base:140cm right				
	90	160 90/90				
		table base:140cm lefthanded				

Options

x		f	l	y		k
Table top surface		Metal surface	Base inlay surface	Front panel surface		Cable cover
42=Silber 1F=Black 2E=Hazel decor LG=Light grey 1P=Grey-white	KV=Beech decor 1J=Maple decor 1N=Walnut decor KS=Cherry decor 1D=Apple decor	23=Platina met 10=Black 21=Anthracite metal 46=Pure white white	----=No Base inlay 23=Platina metal 10=Black 21=Anthracite metal 46=Pure white (Extra charge for base inlay)	----=No front panel 42=Silber 1F=Black 2E=Hazel decor LG=Light grey 1P=Grey-white (Extra charge for front panel)	KV=Beech decor 1J=Maple decor 1N=Walnut decor KS=Cherry decor 1D=Apple decor	J=Cable cover on the right B=Cable cover on the left K=Cable cover on both sides (Extra charge for cable covers)



Tables with 25 mm straight edge laminated table tops that may be connected to 60 cm deep extension tables

Basic design without base inlay, front panel or cable cover			Extra designs			
Height: 75 cm			set of two base inlays For C-shaped bases	Laminated front panel	One cable cover on the right (J) or on the left (B)	2 table covers both sides
Sizes (cm)						
length	depth					
 180	90/90 table base:160cm righthanded	CH610J				
 180	90/90 table base:160cm lefthanded	CH610B				
 160/60	110/80 righthanded connecting edge 80/60 cm	CH811J				
 160/60	110/80 lefthanded connecting edge 80/60 cm	CH811B				
 180/60	110/80 righthanded connecting edge 80/60 cm	CH810J				
 180/60	110/80 lefthanded connecting edge 80/60 cm	CH810B				
 200/60	110/80 righthanded connecting edge 80/60 cm	CH809J				
 200/60	110/80 lefthanded connecting edge 80/60 cm	CH809B				

Options

x		f	l	y		k
Table top surface		Metal frame surface	Base inlay surface	Front panel surface		Cable cover
42=Silber 1F=Black 2E=Hazel decor LG=Light grey 1P=Grey-white	KV=Beech decor 1J=Maple decor 1N=Walnut decor KS=Cherry decor 1D=Apple decor	23=Platina met 10=Black 21=Anthracite metal 46=Pure white white	----=No Base inlay 23=Platina metal 10=Black 21=Anthracite metal 46=Pure white (Extra charge for base inlay)	----=No front panel 42=Silber 1F=Black 2E=Hazel decor LG=Light grey 1P=Grey-white (Extra charge for front panel)	KV=Beech decor 1J=Maple decor 1N=Walnut decor KS=Cherry decor 1D=Apple decor	J=Cable cover on the right B=Cable cover on the left K=Cable cover on both sides (Extra charge for cable covers)

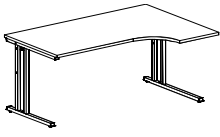
Tables with 25 mm straight edge laminated table tops connecting to side cabinets

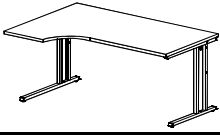
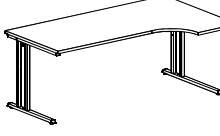
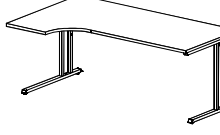
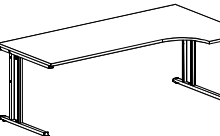
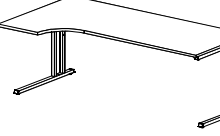
Basic design without base inlay, front panel or cable cover			Extra designs			
Height: 75 cm	Sizes (cm)		set of two base inlays For C-shaped bases	Laminated front panel	One cable cover on the right (J) or on the left (B)	2 table covers both sides
	length	depth				
	160/44	110/80	CH511J			
80 44 righthanded connecting edge 80/44 cm						
	160/44	110/80	CH511B			
80 44 lefthanded connecting edge 80/44 cm						
	180/44	110/80	CH510J			
80 44 righthanded connecting edge 80/44 cm						
	180/44	110/80	CH510B			
80 44 lefthanded connecting edge 80/44 cm						
	200/44	110/80	CH509J			
80 44 righthanded connecting edge 80/44 cm						
	200/44	110/80	CH509B			
80 44 lefthanded connecting edge 80/44 cm						



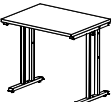
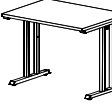
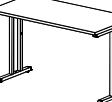

60 cm deep extension tables with 25 mm squared, straight edge laminated table tops

	80	60	CH133N			
	90	60	CH134N			
	120	60	CH132N			

Options

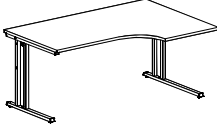
x		f	l	y		k
Table top surface		Metal frame surface	Base inlay surface	Front panel surface		Cable cover
42=Silber 1F=Black 2E=Hazel decor LG=Light grey 1P=Grey-white	KV=Beech decor 1J=Maple decor 1N=Walnut decor KS=Cherry decor 1D=Apple decor	23=Platina met 10=Black 21=Anthracite metal 46=Pure white white	----=No Base inlay 23=Platina metal 10=Black 21=Anthracite metal 46=Pure white (Extra charge for base inlay)	----=No front panel 42=Silber 1F=Black 2E=Hazel decor LG=Light grey 1P=Grey-white (Extra charge for front panel)	KV=Beech decor 1J=Maple decor 1N=Walnut decor KS=Cherry decor 1D=Apple decor (Extra charge for cable covers)	J=Cable cover on the right B=Cable cover on the left K=Cable cover on both sides (Extra charge for cable covers)

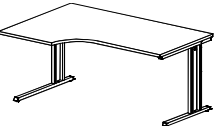
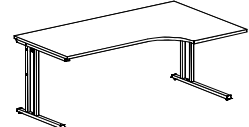
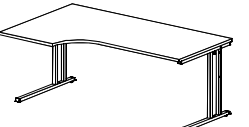
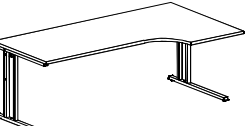
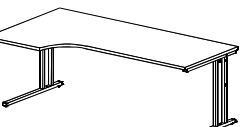

Tables with 25 mm straight edge laminated table tops that may be connected to 60 cm deep extension tables

Basic design without base inlay, front panel or cable cover			Extra designs				
Height: 75 cm	Sizes (cm)		set of two base inlays For C-shaped bases	Laminated front panel	One cable cover on the right (J) or on the left (B)	2 table covers both sides	
	length	depth					
	160/60	110/80			  		
80 60 righthanded connecting edge 80/60 cm							CH411J
	160/60	110/80					CH411B
80 60 lefthanded connecting edge 80/60 cm							
	180/60	110/80					CH410J
80 60 righthanded connecting edge 80/60 cm							
	180/60	110/80					CH410B
80 60 lefthanded connecting edge 80/60 cm							
	200/60	110/80	CH409J				
80 60 righthanded connecting edge 80/60 cm							
	200/60	110/80	CH409B				
80 60 lefthanded connecting edge 80/60 cm							

Options

x		f	k
Table top surface		Steel frame surface	Cable cover
42=Silber 1F=Black 2E=Hazel decor LG=Light grey 1P=Grey-white	KV=Beech decor 1J=Maple decor 1N=Walnut decor KS=Cherry decor 1D=Apple decor	23=Platina metal 10=Black 21=Anthracite metal 46=Pure white	J=Cable cover on the right B=Cable cover on the left K=Cable cover on both sides (Extra charge for cable covers)

70 cm deep tables with 19 or 25 mm squared, straight edge laminated table tops

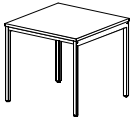
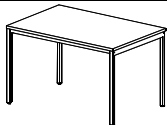
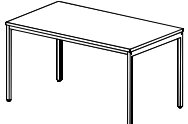
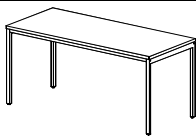
Basic design, no cable cover				Extra designs		
Height: 75 cm	Sizes (cm)		with 19 mm thick table top (CLA...)	with 25 mm thick table top (CLB...)	One cable cover on the right (J) or on the left (B)	Two cable covers both sides
	length	depth				
	80	70	CLA121N	CLB121N		
	120	70	CLA122N	CLB122N		
	140	70	CLA123N	CLB123N		
	160	70	CLA124N	CLB124N		

80 cm deep tables with 19 or 25 mm squared, straight edge laminated table tops

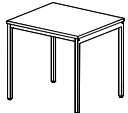
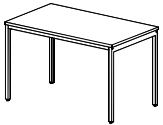
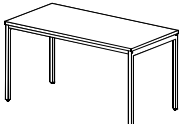
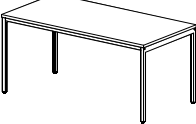
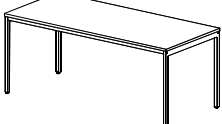
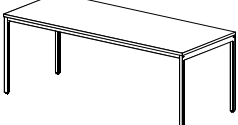

	80	80	CLA113N	CLB113N		
	120	80	CLA112N	CLB112N		
	140	80	CLA114N	CLB114N		
	160	80	CLA111N	CLB111N		
	180	80	CLA110N	CLB110N		
	200	80	CLA109N	CLB109N		

Options

x	f	k
Table top surface	Steel frame surface	Cable cover
42=Silber 1F=Black 2E=Hazel decor LG=Light grey 1P=Grey-white	KV=Beech decor 1J=Maple decor 1N=Walnut decor KS=Cherry decor 1D=Apple decor	23=Platina metal 10=Black 21=Anthracite metal 46=Pure white

J=Cable cover on the right
B=Cable cover on the left
K=Cable cover on both sides
(Extra charge for cable covers)

Freeform tables with 19 mm or 25 mm, straight edge laminated table tops

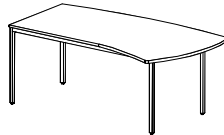
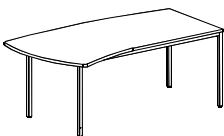
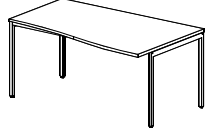
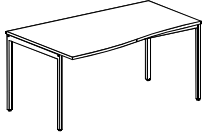
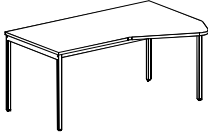
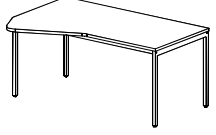
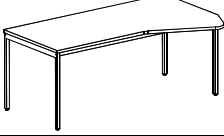
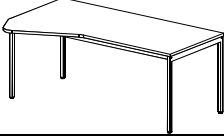
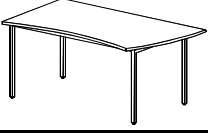
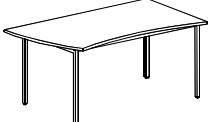

Basic design, no cable cover			Extra designs			
Height: 75 cm	Sizes (cm)		with 19 mm table top (CLA...)	with 25 mm table top (CLB...)	1 cable cover on the right (J), or on the left (B)	2 cable covers both sides
	length	depth				
	180	102,5	CLASH1J	CLBSH1J		
table base:160cm righthanded connecting edge 80 cm						
	180	102,5	CLASH1B	CLBSH1B		
table base:160cm lefthanded connecting edge 80 cm						
	160	100/80	CLASH2J	CLBSH2J		
table base:140cm righthanded connecting edge 80 cm						
	160	100/80	CLASH2B	CLBSH2B		
table base:140cm lefthanded connecting edge 80 cm						
	160	108/80	CLAET0J	CLBET0J		
table base:140cm righthanded connecting edge 80 cm						
	160	108/80	CLAET0B	CLBET0B		
table base:140cm lefthanded connecting edge 80 cm						
	180	108/80	CLAET1J	CLBET1J		
table base:140cm righthanded connecting edge 80 cm						
	180	108/80	CLAET1B	CLBET1B		
table base:140cm lefthanded connecting edge 80 cm						
	160	90/90	CLA611J	CLB611J		
table base:140cm righthanded connecting edge 90 cm						
	160	90/90	CLA611B	CLB611B		
table base:140cm lefthanded connecting edge 90 cm						

Options

x	f	k
Table top surface	Steel frame surface	Cable cover
42=Silber 1F=Black 2E=Hazel decor LG=Light grey 1P=Grey-white	KV=Beech decor 1J=Maple decor 1N=Walnut decor KS=Cherry decor 1D=Apple decor	23=Platina metal 10=Black 21=Anthracite metal 46=Pure white

J=Cable cover on the right
B=Cable cover on the left
K=Cable cover on both sides
(Extra charge for cable covers)

Freeform tables with 19 mm or 25 mm, straight edge laminated table tops

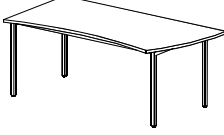
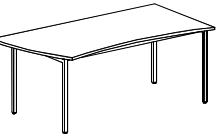
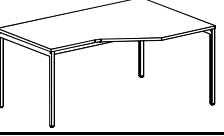
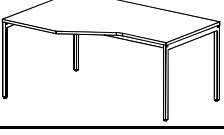
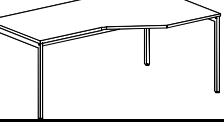
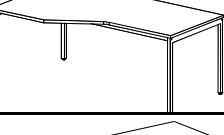
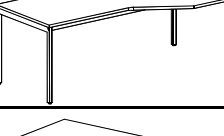
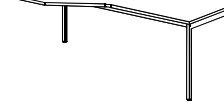
Basic design, no cable cover				Extra designs		
Height: 75 cm	Sizes (cm)		with 19 mm table top (CLA...)	with 25 mm table top (CLB...)	1 cable cover on the right (J), or on the left (B)	2 cable covers both sides
	length	depth				
	180	90/90	CLA610J	CLB610J		
	table base:160cm righthanded					
	180	90/90	CLA610B	CLB610B		
	table base:160cm lefthanded					
	160/60	110/80	CLA811J	CLB811J		
	righthanded connecting edge 80/60 cm					
	160/60	110/80	CLA811B	CLB811B		
	lefthanded connecting edge 80/60 cm					
	180/60	110/80	CLA810J	CLB810J		
	righthanded connecting edge 80/60 cm					
	180/60	110/80	CLA810B	CLB810B		
	lefthanded connecting edge 80/60 cm					
	200/60	110/80	CLA809J	CLB809J		
	righthanded connecting edge 80/60 cm					
	200/60	110/80	CLA809B	CLB809B		
	lefthanded connecting edge 80/60 cm					

Metal cable channels to be installed afterwards for "4" legged tables

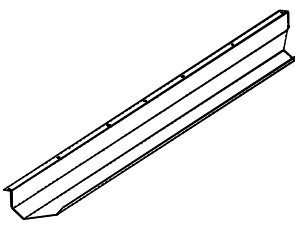
	length		
	To 60 cm long tables	25 cm	M60y
	To 80 cm long tables	45 cm	M61y
	To 120 cm long tables	65 cm	M62y
	To 140 cm long tables	90 cm	M63y
	To 160 cm long tables	110 cm	M64y
	To 180 cm long tables	130 cm	M65y
	To 200 cm long tables	150 cm	M66y



Valid from:01/07/2010. Published:01/06/2010.

Options

x	f	k
Table top surface	Steel frame surface	Cable cover
42=Silber 1F=Black 2E=Hazel decor LG=Light grey 1P=Grey-white	KV=Beech decor 1J=Maple decor 1N=Walnut decor KS=Cherry decor 1D=Apple decor	23=Platina metal 10=Black 21=Anthracite metal 46=Pure white

J=Cable cover on the right
B=Cable cover on the left
K=Cable cover on both sides
(Extra charge for cable covers)

Tables with 25 or 19 mm straight edge, laminated table tops connecting to side cabinets

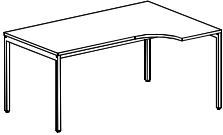
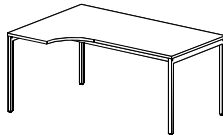
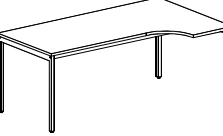
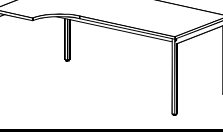
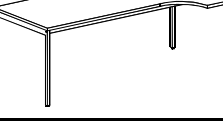
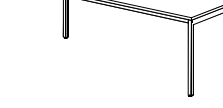
Basic design, no cable cover				Extra designs			
Height: 75 cm	Sizes (cm)		with 19 mm table top (CLA...)	with 25 mm table top (CLB...)	1 cable cover on the right (J), or on the left (B)	2 cable covers both sides	
	length	depth					
	80	44	160/44	110/80	CLA511J	CLB511J	
			righthanded connecting edge 80/44 cm				
	80	44	160/44	110/80	CLA511B	CLB511B	
			lefthanded connecting edge 80/44 cm				
	80	44	180/44	110/80	CLA510J	CLB510J	
			righthanded connecting edge 80/44 cm				
	80	44	180/44	110/80	CLA510B	CLB510B	
			lefthanded connecting edge 80/44 cm				
	80	44	180/44	110/80	CLA509J	CLB509J	
			righthanded connecting edge 80/44 cm				
	80	44	180/44	110/80	CLA509B	CLB509B	
			lefthanded connecting edge 80/44 cm				

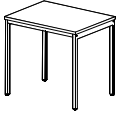
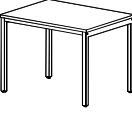
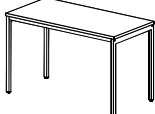

60 cm deep extension tables with 19 mm or 25 mm squared, straight edge laminated table tops

	80	60	CLA133N	CLB133N		
	90	60	CLA134N	CLB134N		
	120	60	CLA132N	CLB132N		

Options

x		f	k
Table top surface		Steel frame surface	Cable cover
42=Silber 1F=Black 2E=Hazel decor LG=Light grey 1P=Grey-white	KV=Beech decor 1J=Maple decor 1N=Walnut decor KS=Cherry decor 1D=Apple decor	23=Platina metal 10=Black 21=Anthracite metal 46=Pure white	J=Cable cover on the right B=Cable cover on the left K=Cable cover on both sides (Extra charge for cable covers)

Tables with 25 or 19 mm straight edge, laminated table tops that may be connected to 60 cm deep extension tables

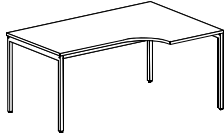
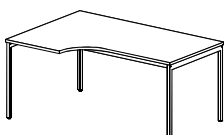
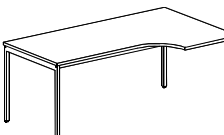
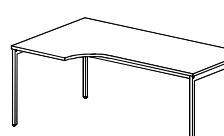
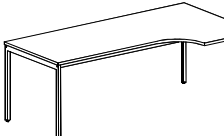
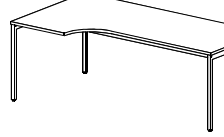
Basic design, no cable cover				Extra designs		
Height: 75 cm	Sizes (cm)		with 19 mm table top (CLA...)	with 25 mm table top (CLB...)	1 cable cover on the right (J), or on the left (B)	2 cable covers both sides
	length	depth				
	160/60	110/80	CLA411J	CLB411J		
80 60 righthanded connecting edge 80/60 cm						
	160/60	110/80	CLA411B	CLB411B		
60 80 lefthanded connecting edge 80/60 cm						
	180/60	110/80	CLA410J	CLB410J		
80 60 righthanded connecting edge 80/60 cm						
	180/60	110/80	CLA410B	CLB410B		
60 80 lefthanded connecting edge 80/60 cm						
	200/60	110/80	CLA409J	CLB409J		
80 60 righthanded connecting edge 80/60 cm						
	200/60	110/80	CLA409B	CLB409B		
60 80 lefthanded connecting edge 80/60 cm						

Corner table tops for "C" base and four-legged tables, with connectors

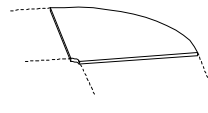
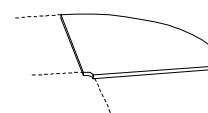
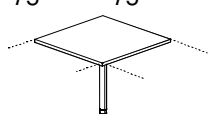
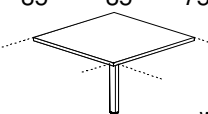
length	depth	high	angle	19 mm thick top panel	25 mm thick top panel	length	depth	high	angle	19 mm thick top panel	25 mm thick top panel
75	75		90°	CAS35	CBS35	85	85		90°	CAS31	CBS31
											
without front panel						without front panel					
75	75	75	90°	CAS85	CBS85	85	85	75	90°	CBS81	CBS81
											
with one leg						with one leg					

Options

x				f	
Table top surface				Metal surface	
42=Silber	1P=Grey-white	KS=Cherry decor	LG=Light grey	23=Platina metal	46=Pure white
1F=Black	KV=Beech decor	1D=Apple decor		10=Black	
2E=Hazel decor	1J=Maple decor	1N=Walnut decor		21=Anthracite metal	

Extension table tops for "C" base and four-legged tables, with connectors

<p>140 70 75 with one leg</p>	<p>CAP06</p> <p>connecting edges 2x70 cm</p>	<p>CBP06</p>	<p>160 80 75 with one leg</p>	<p>CAP03</p> <p>connecting edges 2x80 cm</p>	<p>CBP03</p>
<p>140 60 75 with one leg</p>	<p>CAP58</p> <p>connecting edges 2x70 cm</p>	<p>CBP58</p>	<p>160 60 75 with one leg</p>	<p>CAP51</p> <p>connecting edges 2x80 cm</p>	<p>CBP51</p>
<p>140 40 75 with one leg</p>	<p>CAP48</p> <p>connecting edges 2x70 cm</p>	<p>CBP48</p>	<p>160 40 75 with one leg</p>	<p>CAP43</p> <p>connecting edges 2x80 cm</p>	<p>CBP43</p>
<p>70 35 75 with one leg</p>	<p>CAP07</p> <p>connecting edge 70 cm</p>	<p>CBP07</p>	<p>80 40 75 with one leg</p>	<p>CAP01</p> <p>connecting edge 80 cm</p>	<p>CBP01</p>
<p>160 50 75 with one leg</p>	<p>CAP54</p> <p>connecting edge 2x80 cm</p>	<p>CBP54</p>	<p>160 80 75 with two legs</p>	<p>CAP50</p> <p>connecting edge 80 cm</p>	<p>CBP50</p>
<p>120 70 75 with two legs</p>	<p>CAP77</p> <p>connecting edge 70 cm</p>	<p>CBP77</p>	<p>120 80 75 with two legs</p>	<p>CAP71</p> <p>connecting edge 80 cm</p>	<p>CBP71</p>
<p>105 105 75 with two legs</p>	<p>CAP97J CAP97B</p> <p>connecting edge 70 cm</p>	<p>CBP97J CBP97B</p>	<p>120 120 75 with two legs</p>	<p>CAP98J CAP98B</p> <p>connecting edge 80 cm</p>	<p>CBP98J CBP98B</p>
<p>140 140 75 with two legs</p>	<p>CAP87J CAP87B</p> <p>connecting edge 70 cm</p>	<p>CBP87J CBP87B</p>	<p>160 160 75 with two legs</p>	<p>CAP88J CAP88B</p> <p>connecting edge 80 cm</p>	<p>CBP88J CBP88B</p>
<p>119,5 70 75 with two legs</p>	<p>CAP67J CAP67B</p> <p>connecting edge 70 cm</p>	<p>CBP67J CBP67B</p>	<p>137 80 75 with two legs</p>	<p>CAP61J CAP61B</p> <p>connecting edge 80 cm</p>	<p>CBP61J CBP61B</p>

Valid from:01/07/2010. Published:01/06/2010.

Options

x Top panel surface			f Metal surface	l Base inlay colour (for 'T' base tables only)
42=Silber 1F=Black 2E=Hazel decor LG=Light grey	1P=Grey-white KV=Beech decor 1J=Maple decor 1N=Walnut decor	KS=Cherry decor 1D=Apple decor	23=Platina metal 10=Black 21=Anthracite metal 46=Pure white	23=Platina metal 10=Black 21=Anthracite metal 46=Pure white (Extra charge for base inlay)

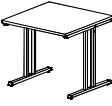
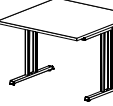
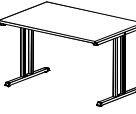
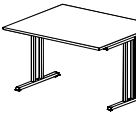
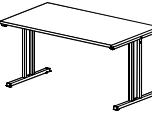
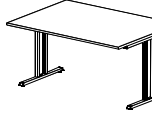
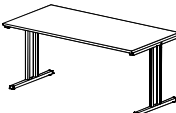
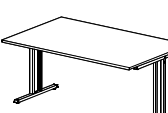
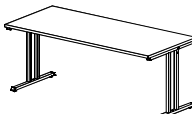
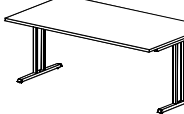
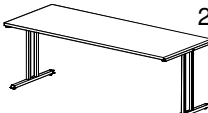
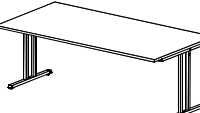
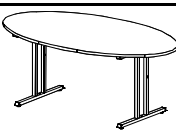
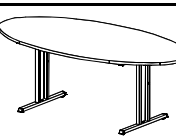
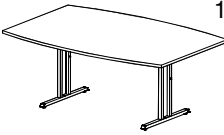
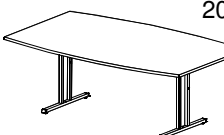
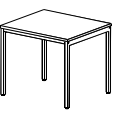
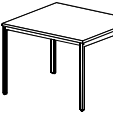
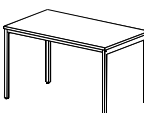
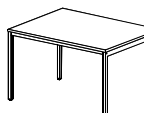
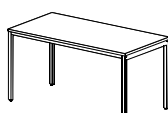
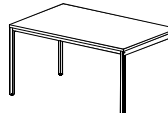
80 cm deep 'T' base conference tables					100 cm deep 'T' base conference tables				
Basic price			Extra design	Basic design			Extra design		
Height: 75 cm	Sizes (cm)		2 pcs base inlay	Height: 75 cm	Sizes (cm)		2 pcs base inlay		
	length	depth			length	depth			
	80	80	CT113N		100	100	CT713N		
	120	80	CT112N		120	100	CT712N		
	140	80	CT114N		140	100	CT714N		
	160	80	CT111N		160	100	CT711N		
	180	80	CT110N		180	100	CT710N		
	200	80	CT109N		200	100	CT709N		
	180	100	CTE18N		200	100	CTE20N		
	180	120	CTC18N		200	120	CTC20N		
80 cm deep "4" legged conference tables					100 cm deep "4" legged conference tables				
Height: 75 cm	Sizes (cm)		19 mm thick top panel	25 mm thick top panel	Height: 75 cm	Sizes (cm)		19 mm thick top panel	25 mm thick top panel
	length	depth	CLA113N	CLB113N		length	depth	CLA713N	CLB713N
	80	80				100	100		
	120	80	CLA112N	CLB112N		120	100	CLA712N	CLB712N
	140	80	CLA114N	CLB114N		140	100	CLA714N	CLB714N

Options

x			f
Top panel surface			Metal surface
42=Silber	1P=Grey-white	KS=Cherry decor	23=Platina metal
1F=Black	KV=Beech decor	1D=Apple decor	10=Black
2E=Hazel decor	1J=Maple decor		21=Anthracite metal
LG=Light grey	1N=Walnut decor		46=Pure white

80 cm deep "4" legged conference tables

100 cm deep "4" legged conference tables

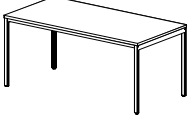
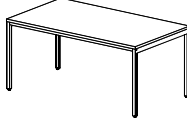
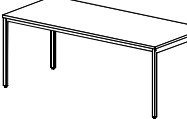
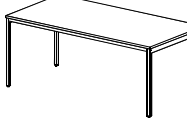
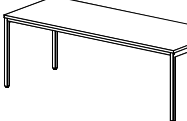
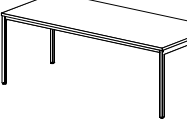
80 cm deep "4" legged conference tables				100 cm deep "4" legged conference tables					
Height: 75 cm	length	depth	19 mm thick top panel	25 mm thick top panel	Height: 75 cm	length	depth	19 mm thick top panel	25 mm thick top panel
	160	80	CLA111N	CLB111N		160	100	CLA711N	CLB711N
	180	80	CLA110N	CLB110N		180	100	CLA710N	CLB710N
	200	80	CLA109N	CLB109N		200	100	CLA709N	CLB709N

Conference tables with one pillar leg

Conference tables with two pillar legs

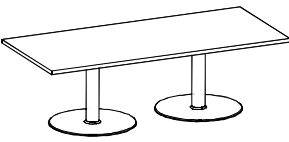
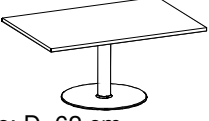
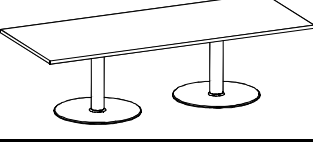
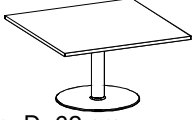
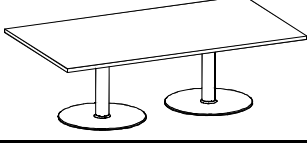
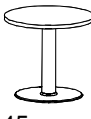
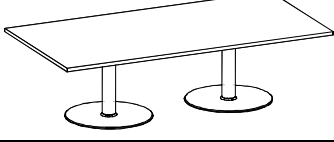
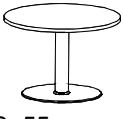
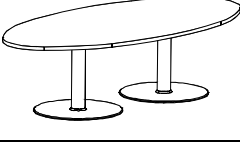
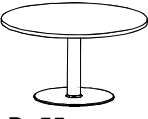
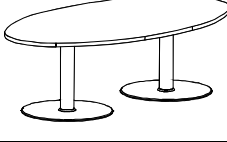
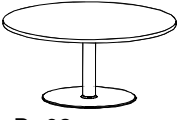
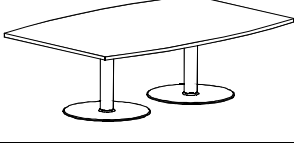
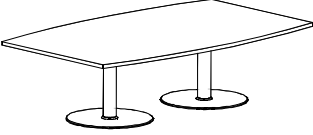
Conference tables with one pillar leg			Conference tables with two pillar legs				
Height: 72 cm	Sizes (cm)			Height: 72 cm	Sizes (cm)		
	length	depth			length	depth	
	80	80	CR088N		180	80	CR188N
Socle: D=55 cm				Socle: D=55 cm			
	120	80	CR128N		200	80	CR208N
Socle: D=62 cm				Socle: D=55 cm			
	100	100	CR100N		180	100	CR180N
Socle: D=62 cm				Socle: D=62 cm			
	60	60	CRD60N		200	100	CR200N
Socle: D=45 cm				Socle: D=62 cm			
	80	80	CRD80N		180	100	CRE18N
Socle: D=55 cm				Socle: D=55 cm			
	100	100	CRD10N		200	100	CRE20N
Socle: D=55 cm				Socle: D=55 cm			
	120	120	CRD12N		180	120	CRC18N
Socle: D=62 cm				Socle: D=62 cm			
Column leg table's socle is 8 mm thick steel sheet. The column leg's diameter always 9 cm. The tables are 72 cm height, and if you put up for the 75 cm height design is possible. Please always prognosticate this.					200	120	CRC20N
				Socle: D=62 cm			